

## SMALL BLANCHARD CLOUD INSTALL GUIDE

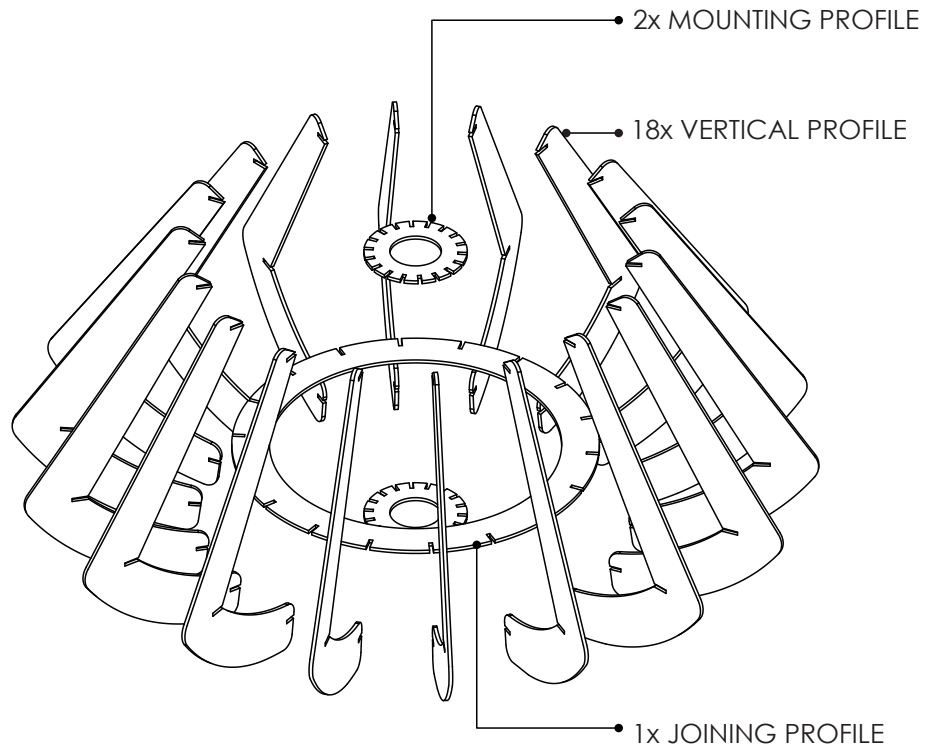

[www.crownsurfacesolutions.com](http://www.crownsurfacesolutions.com)  
e: [info@crownsurfacesolutions.com](mailto:info@crownsurfacesolutions.com)  
p: 416.245.2900

# SMALL BLANCHARD CLOUD ASSEMBLY



1) Assemble cloud profiles as shown.

**STEP 1**

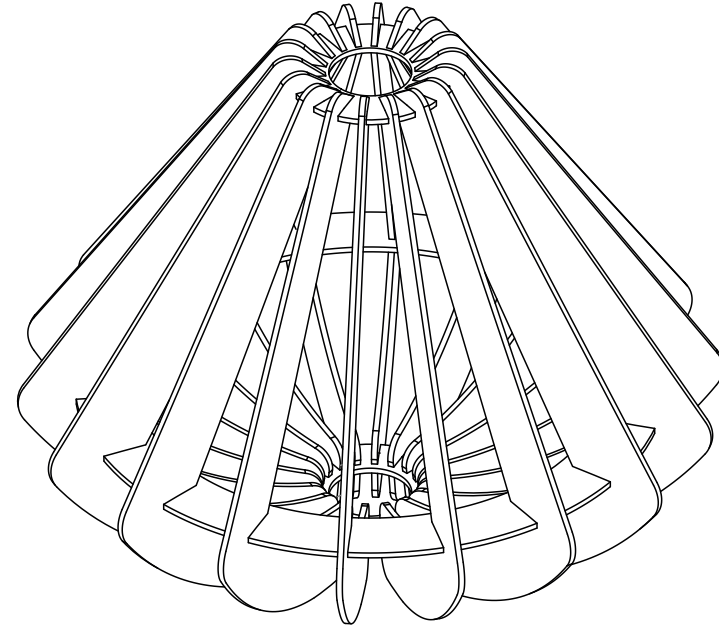

2) Assembly is complete.

**STEP 2**

## SMALL BLANCHARD CLOUD SUSPENSION METHOD

3) Place cloud assembly up to ceiling in desired location. Mark position of through holes which correspond to the centre of each "set" of mounting slits on the mounting profile. Test that hole position is correct by temporarily suspending cloud on wires as shown in STEP 7 & 8.

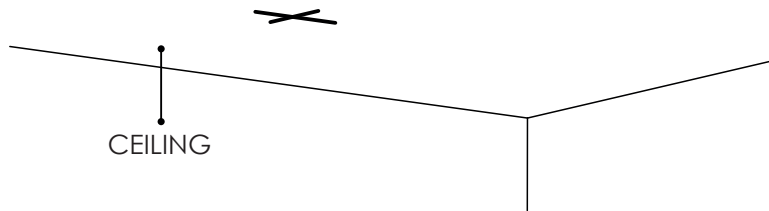

4) Consulting the "**Baresque Systems Fixing Directory**", select the appropriate fixing method for your substrate & install 'hanger head'. **Please note, screws are not supplied.**

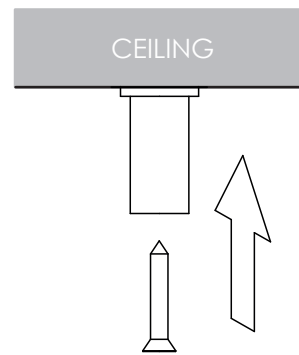

**STEP 3 & 4**

5) Feed swaged wire through tip of 'wire adjuster' (as shown). Push button (shown in grey) to adjust wire length. Release the button to lock in place.

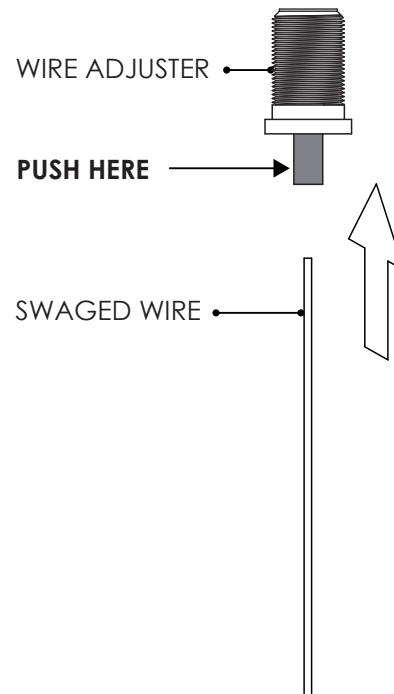

6) Feed swaged wire through hole in the side of 'hanger head'. Screw 'wire adjuster' into 'hanger head'. Adjust wire to desired length.

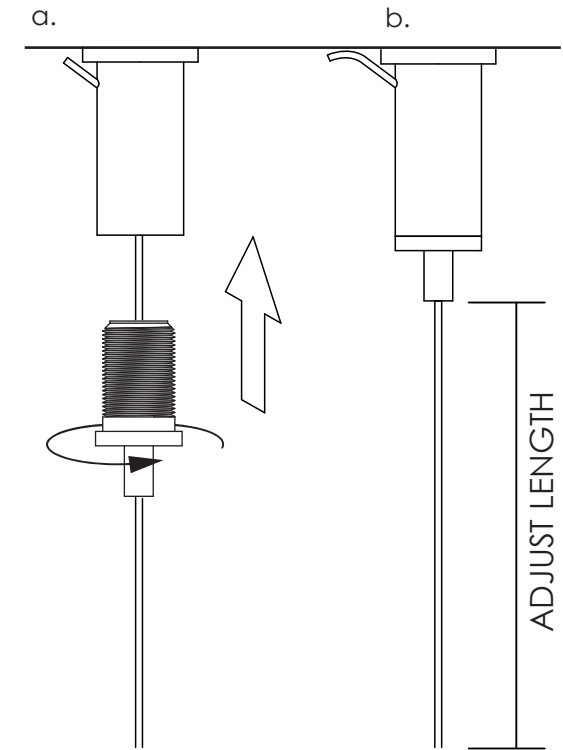

**STEP 5 & 6**

## SMALL BLANCHARD CLOUD SUSPENSION METHOD

7) Insert 'S' hooks into mounting slits on cloud as shown.



8) Suspend cloud by looping 'S' hooks through swaged wire.  
Note- 2 'S' hooks are required per wire.

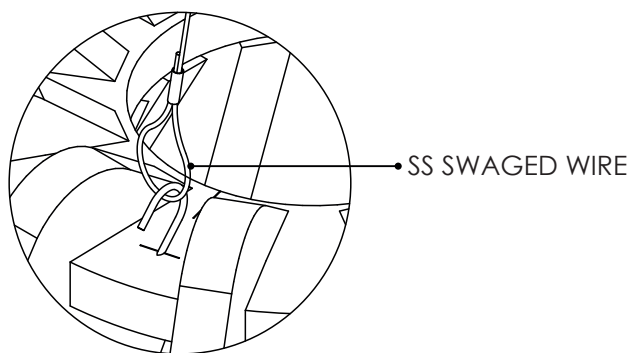

**STEP 7 & 8**

9) Re-adjust wire length as explained in STEP 5 until cloud hangs level.  
Note, there are 2 orientation options as shown below.

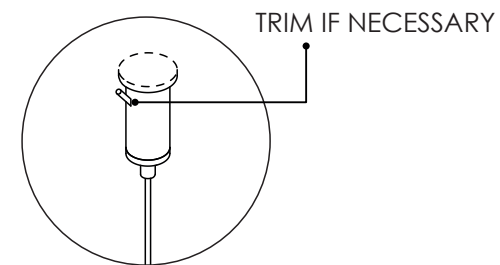
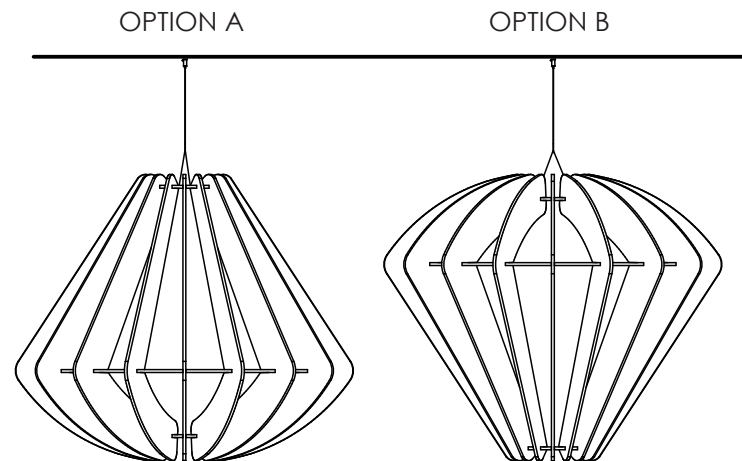

**STEP 9**

\*Please note, above linework is representative only.  
Your cloud may not be depicted.

# SMALL BLANCHARD CLOUD PARTS

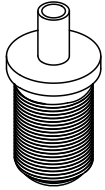

**WIRE ADJUSTER**  
1 OFF

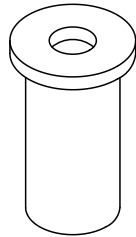

**HANGER HEAD**  
1 OFF



**'S' HOOK**  
2 OFF

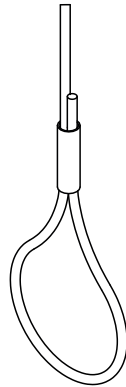

**SWAGED WIRE Y-FIT**  
1 OFF

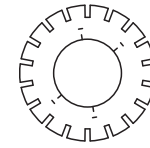

**MOUNTING PROFILE**  
2 OFF

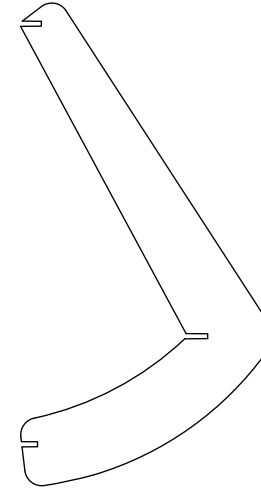

**VERTICAL PROFILE**  
18 OFF

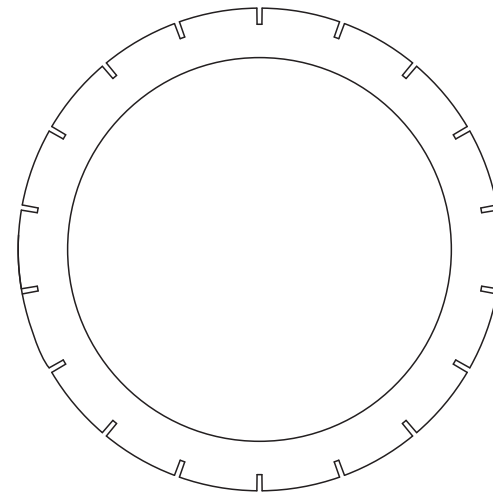

**JOINING PROFILE**  
1 OFF